

# ESTUN



## AC Servo Motor

*Best Suited for High-performance  
Heavy-duty Applications*



ISO9001



# AC Servo Motor

## Content

Mighty R&D Platform.....	3
Motor Outline.....	4
EMJ series servo motor.....	5
EMG series servo motor.....	8
EML series servo motor.....	11
EMB series servo motor.....	14
Feedback Unit.....	17
Typical applications.....	18

### Ginkgo Lake Int'l Golf land

Ginkgo Lake International Golf lies under the foot of Oxhead Mountain and is about ten miles away from Estun with 27 holes. Designed by David Jonsa, it is an international standard golf land.

# Motor Testing System

## Mighty R&D Platform

Estun is the only China's servo motor manufacturer who owns a motor R&D department with mighty R&D platform. AC servo motor's research and testing devices details are as follows:

1. **Maxwell 3D**, a top internationally renowned FEA software from **ANSOFT, USA**, with functions to operate analysis on AC servo's 3D EMF, transient field, temperature filed and stress filed ,and **RMxpert**, a software on the analysis and design of rotating motor, are applied to ensure an internationally first-class AC servo motor.

2. Full set of top international advanced testing system and analysis software on servo motor from **MAGTROL, SWISS**, ensures the functions and performance of Estun AC servo motor could be simulated and verified precisely and scientifically.

3. Full set of electromagnetic interference scanning system and anti-jamming system from **Dtectus, Sweden and Agilent, US**, could be applied to diagnose and analyze the electric filed, magnetic field and thermal distribution at the process of hardware development, which ensures high anti-interference and reliability in their designing process.

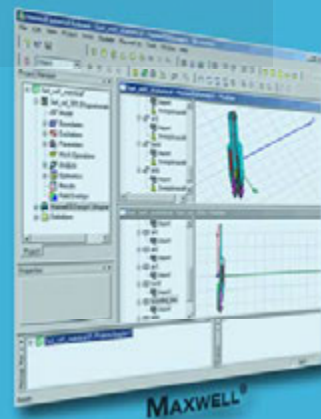
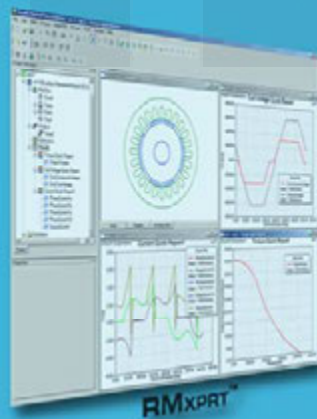
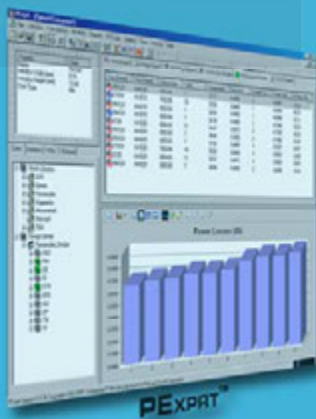
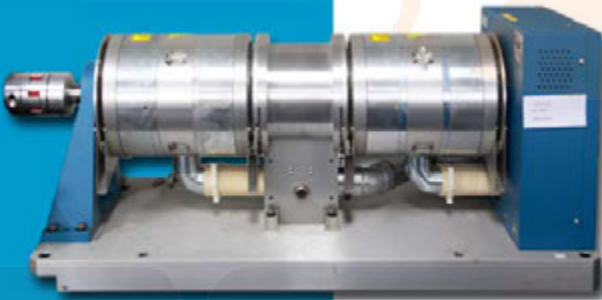
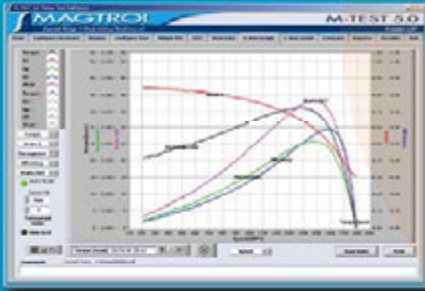

# Motor Outline

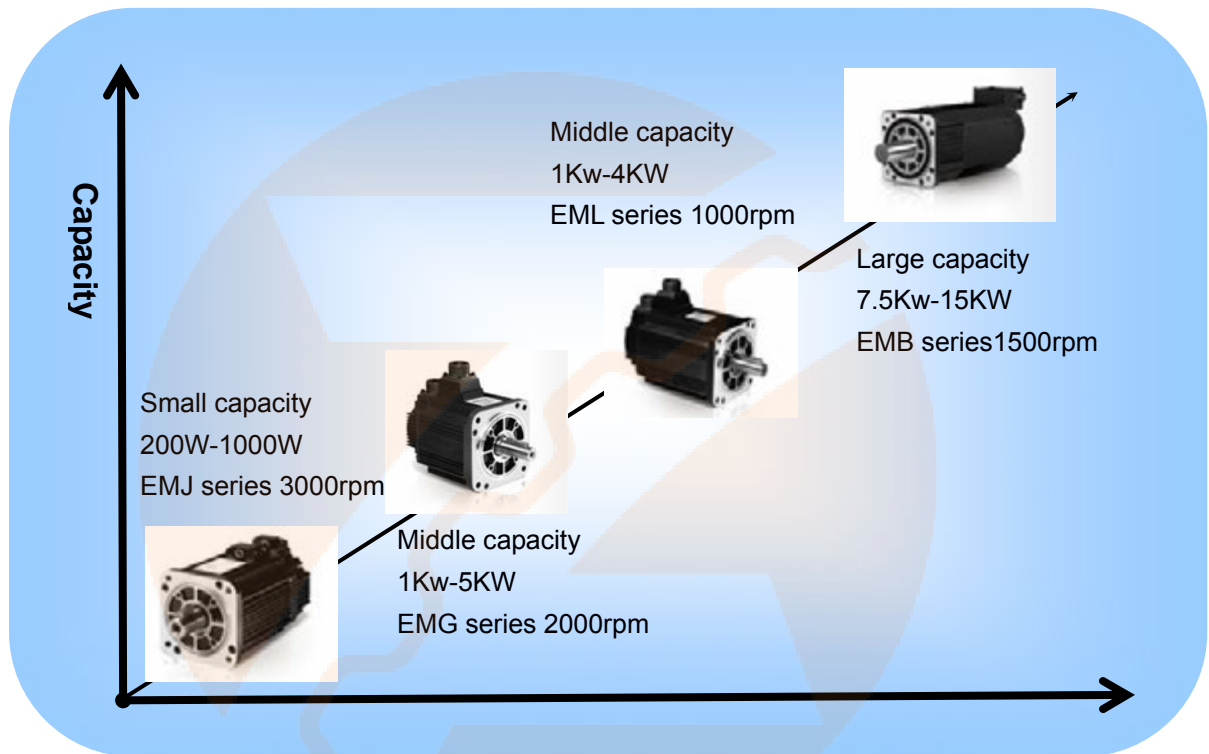

We only choose the best components



Made in China,  
made with the world

**ESTUN**  
Total solution of motion control

# EMJ Series Servo Motor

## Features

- Medium inertia
- Peak torque up to 300% of rated torque
- Various models (200w~1000w, with brake, etc.)
- Run at speed of up to 4500r/min
- IP68 level water-proof connector
- Equipped with 2500P/R, 17-bit incremental/absolute encoder



## Applications

- SMM(surface mounting machine)
- PCB puncher machine
- Robot arm
- Handling machine
- Foodstuff processing machine
- Textile machine

## Model Specification Description

**EMJ-08**

**A**

**D**

**A**

**1**

**1**

EMJ Model Servo Motor

Rated Power		Power Voltage		Encoder		Design Sequence		Shaft End		Optional Parts	
Sign	Spec.	Sign	Spec.	Sign	Spec.	Sign	Spec.	Sign	Spec.	Sign	Spec.
2	200W	A	200Vac			A	Design Sequence	1	Flat, without keys	1	None
4	400W			D	Incremental Encoder: 131072P/R					2	With Oil Seal
8	750W										
10	1000W			S	Absolute Encoder: 131072P/R			2	Flat, with keys, with screw thread	3	With brake (DC24V)
				R	Resolver					4	With oil seal, with brake (DC24V)

## Rated Value and Specification

Model	Unit	EMJ-02A	EMJ-04A	EMJ-08A	EMJ-10A
Rated power	Kw	0.200	0.4	0.75	1.00
Rated torque	Nm	0.64	1.27	2.40	3.20
Maximum torque	Nm	1.92	3.81	7.2	9.6
Rated rotation speed	rpm	3000		3000	
Top rotation speed	rpm	4500		4500	
Rated current	A	1.300	2.6	4.00	6.00
Instantaneous Max. current	A	3.900	7.8	12.00	18.00
Rotor moment of Inertia (without brake)	E-4Kg.m <sup>2</sup>	0.188	0.313	1.35	1.74
Rotor moment of Inertia (with brake)	E-4Kg.m <sup>2</sup>	0.228	0.354	1.47	1.87
Electric time constant-T <sub>E</sub>	ms	2.391	2.979	11.000	9.938
Mechanical time constant-T <sub>M</sub>	ms	1.203	0.864	1.183	1.239
electromotive force constant-K <sub>E</sub>	V/krpm	31.910	31.63	39	38.4
Torque constant-K <sub>T</sub>	Nm/A	0.564	0.564	0.613	0.613
Resistance among motor windings	Ω	11.000	4.7	2	1.6
inductance among motor windings	mH	24.7~26.3	13.32~14	16.5~22	11.9~15.9
Insulation level		F			
Insulation impedance		Not less than 50MΩ under normal temperature			
Insulation voltage endurance		AC 1500V, 50Hz,1min			
Running air pressure	kPa	86~106			
Running temperature	°C	-25~+40			
Running humidity		Not more than 90%, under 25°C			
IP level		IP65			

## Torque-speed feature

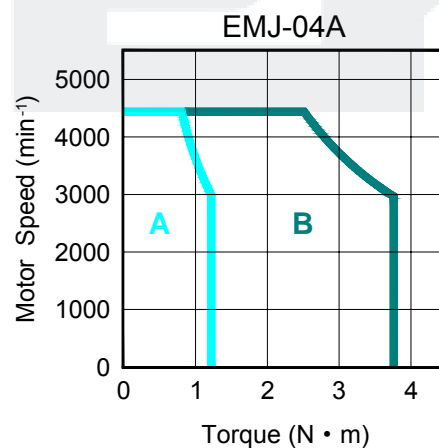
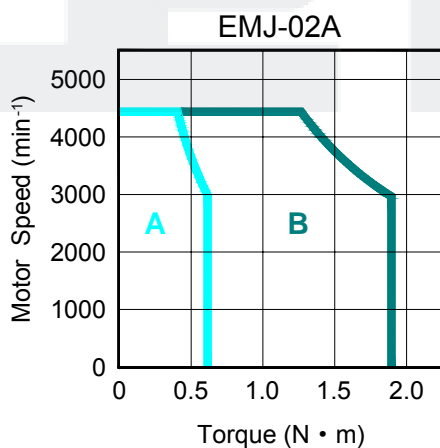

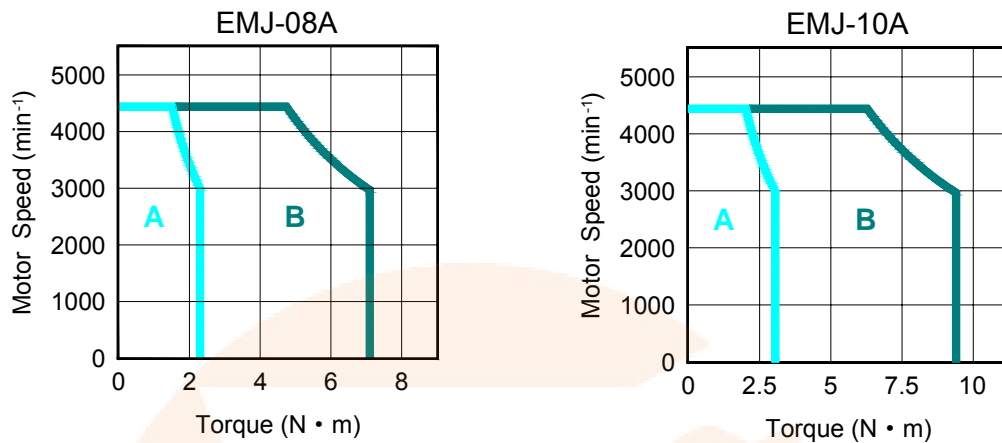

A: Continuous Working Area B: Repeatab Working Area

## Dimension

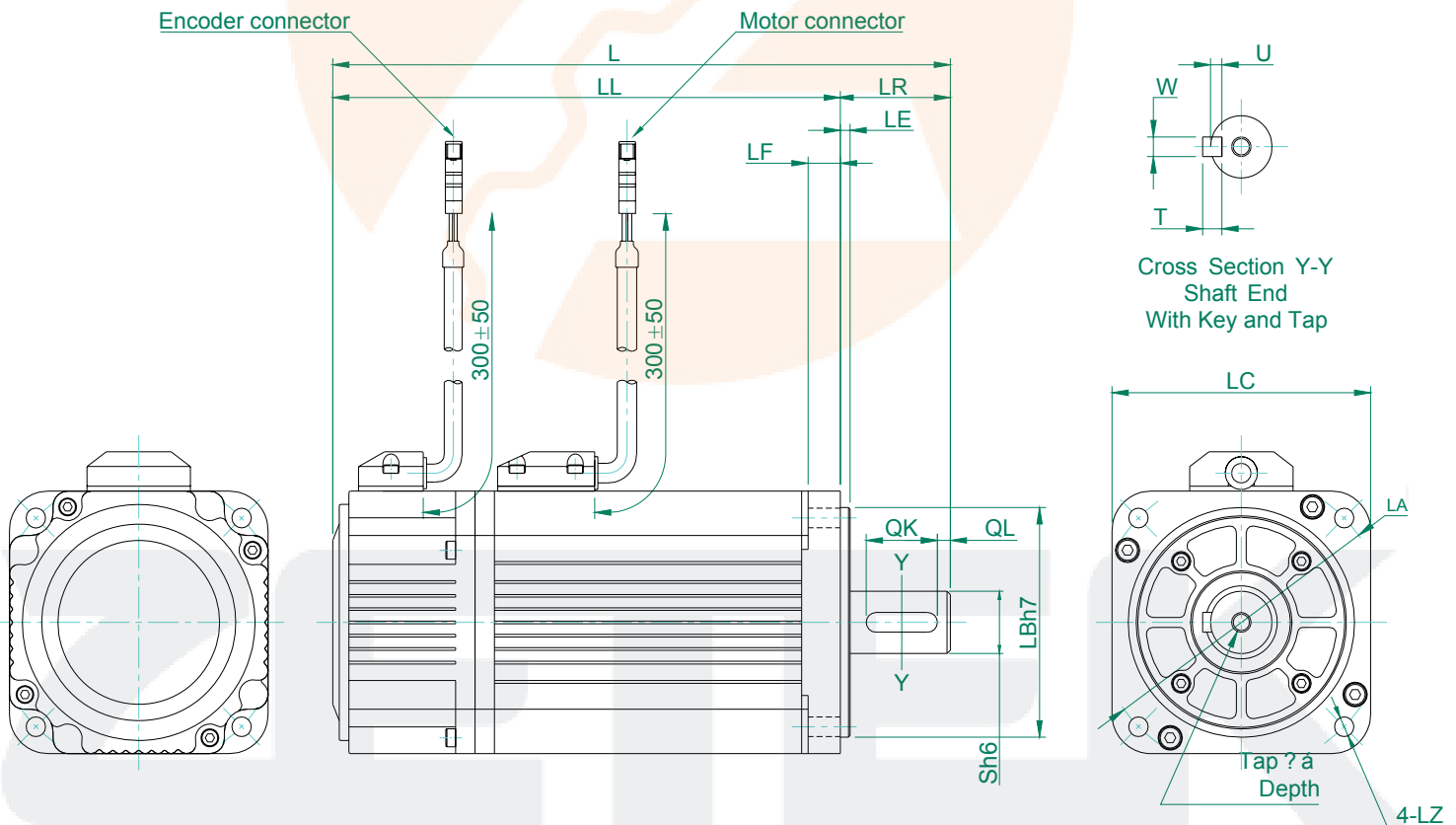

Model EMJ-	L	LL	Flange face							S	Tap×Depth	Key				
			LR	LE	LF	LC	LA	LB	LZ			QK	QL	W	T	U
02A	153	123	30	3	6	60	70	50	5.5	14	M5x10L	16	4	5	5	3
04A	173	143	30	3	6	60	70	50	5.5	14	M5x10L	16	4	5	5	3
08A	191	156	35	3	9	80	90	70	6	19	M6x15L	22	4	6	6	3.5
10A	211	176	35	3	9	80	90	70	6	19	M6x15L	22	4	6	6	3.5

Note: The motor could be short about 13mm when equipped with 2500P/R encoder.

# EMG Series Servo Motor

## Features

- Be used to drive the feed shaft of various machine
- Various products (1.0KW ~5.0KW, with brake etc.)
- Equipped with 17-bit incremental/absolute encoder. Optional mounted resolver.
- Standard configuration is IP65

## Applications

- Machine tools
- Handling machine
- Foodstuff processing machine
- Textile machine



## Model Specification Description

**EMG-10 A D A 1 1**

EMG Model Servo Motor	Rated Power		Power Voltage		Encoder		Design Sequence		Shaft End		Optional Parts	
	Sign	Spec.	Sign	Spec.	Sign	Spec.	Sign	Spec.	Sign	Spec.	Sign	Spec.
	<b>10</b>	1.0KW	<b>A</b>	200Vac	<b>D</b>	Incremental Encoder: 131072P/R	<b>A</b>	Design Sequence	<b>1</b>	Flat, without keys	<b>1</b>	None
	<b>15</b>	1.5KW									<b>2</b>	With Oil Seal
	<b>20</b>	2.0KW			<b>S</b>	Absolute Encoder: 131072P/R			<b>2</b>	Flat, with keys, with screw thread	<b>3</b>	With brake (DC24V)
	<b>30</b>	3.0KW										
	<b>50</b>	5.0KW			<b>R</b>	Resolver					<b>4</b>	With oil seal, with brake (DC24V)



## Rated Value and Specification

**ESTUN**

Model	Unit	EMG-10A	EMG-15A	EMG-20A	EMG-30A	EMG-50A
Rated power	Kw	1.0	1.5	2.0	3.0	5.0
Rated torque	Nm	4.78	7.16	9.55	14.3	23.9
Maximum torque	Nm	14.34	21.48	28.65	42.9	71.7
Rated rotation speed	rpm	2000				
Top rotation speed	rpm	3000				
Rated current	A	6	9	12	18	30
Instantaneous Max. current	A	18	27	36	54	90
Rotor moment of Inertia (without brake)	$E-4Kg.m^2$	10.0324	14.5124	18.9952	41.2788	71.7524
Rotor moment of Inertia (with brake)	$E-4Kg.m^2$	10.6446	15.1236	19.6064	44.4788	74.9524
Electric time constant- $T_E$	ms	11.57	12.75	13.00	12.31	16
Mechanical time constant- $T_M$	ms	1.39	1.16	1.07	2.40	1.57
electromotive force constant- $K_E$	V/krpm	60.9	60	61	57.54	56.2
Torque constant- $K_T$	Nm/A	0.8691	0.8732	0.9183	0.9093	0.852
Resistance among motor windings	$\Omega$	0.7	0.4	0.3	0.29	0.1
inductance among motor windings	mH	7.9~8.1	4.9~5.1	3.7~3.9	2.02~3.57	0.87~1.6
Insulation level		F				
Insulation impedance		Not less than 50M $\Omega$ under normal temperature				
Insulation voltage endurance		AC 1500V, 50Hz, 1min				
Running air pressure	kPa	86~106				
Running temperature	$^{\circ}C$	-25~+40				
Running humidity		Not more than 90%, under 25 $^{\circ}C$				
IP level		IP65				

## Torque-speed feature

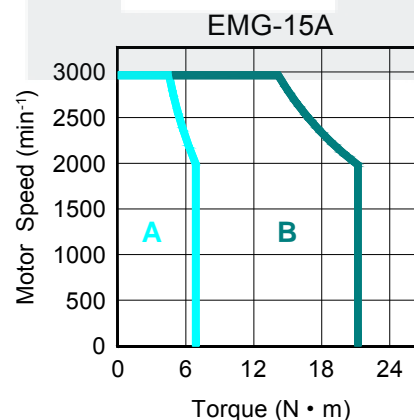
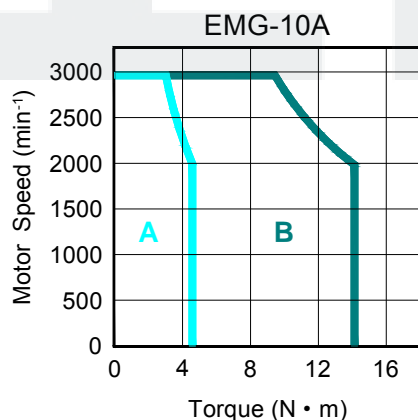

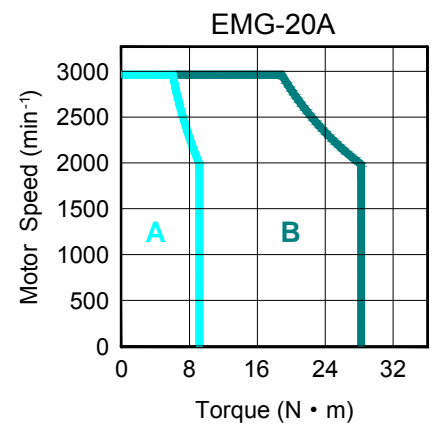
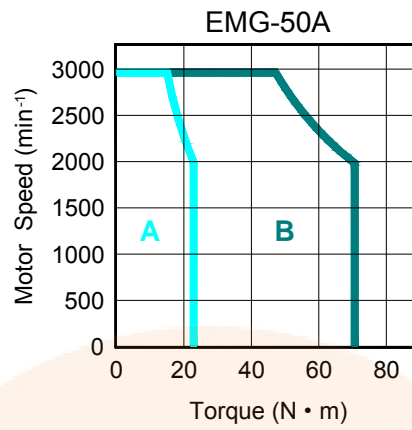
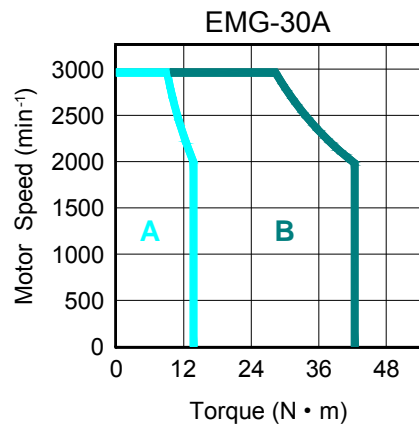

## Dimension

A: Continuous Working Area  
B: Repeatable Working Area

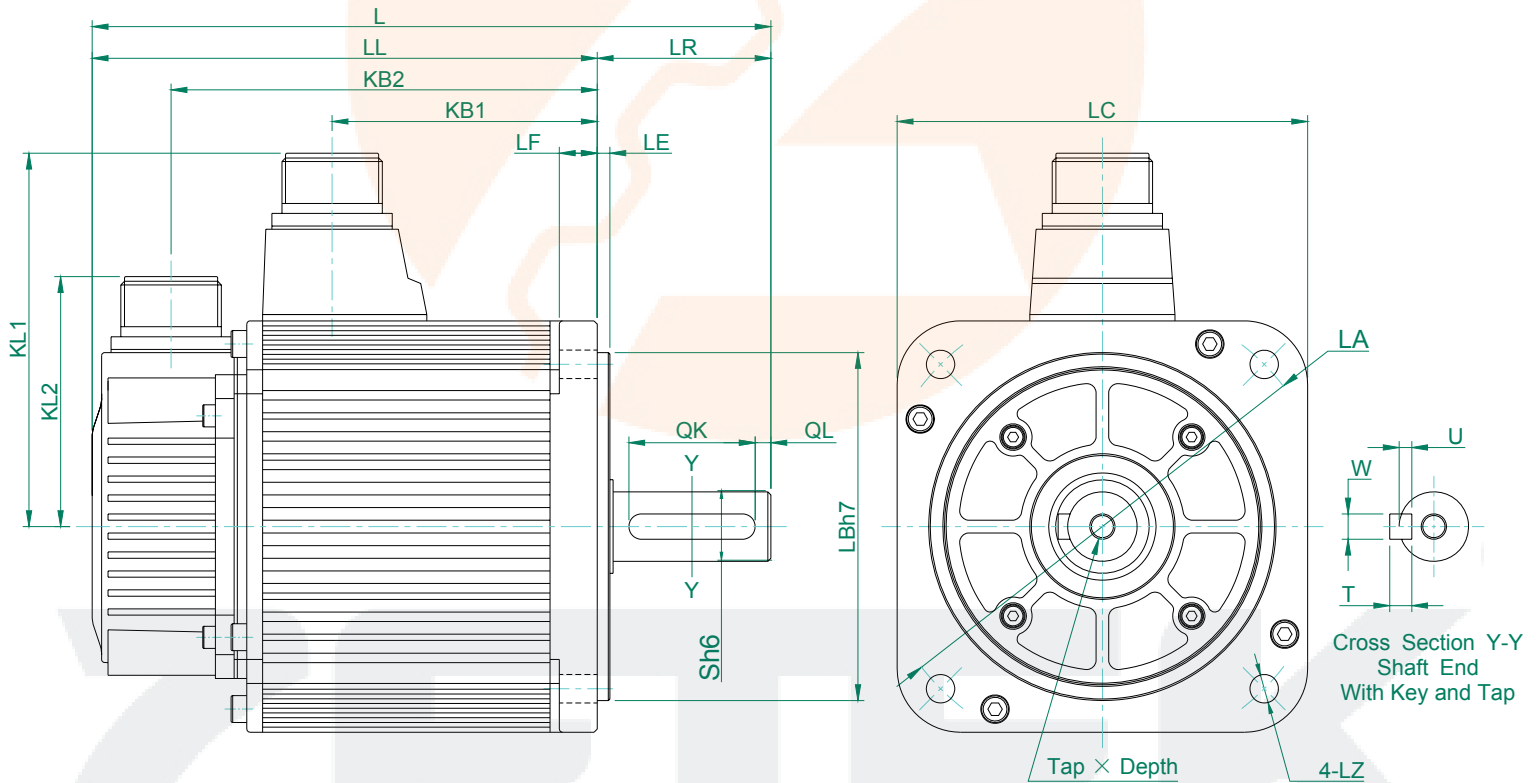

Model EMG-	L	LL	KB1	KB2	KL1	KL2	Flange face						S	Tap×Depth	Key					
							LR	LE	LF	LC	LA	LB			LZ	QK	QL	W	T	U
10A	215	160	84	135	118	79	55	4	12	130	145	110	9	22	M6x20L	40	5	8	7	4
15A	240	185	109	160	118	79	55	4	12	130	145	110	9	22	M6x20L	40	5	8	7	4
20A	265	210	134	185	118	79	55	4	12	130	145	110	9	22	M6x20L	40	5	8	7	4
30A	307	228	143	203	140	79	79	3.2	18	180	200	114.3	13.5	35	M8x16L	55	6	10	8	5
50A	347	268	183	243	140	79	79	3.2	18	180	200	114.3	13.5	35	M8x16L	55	6	10	8	5

# EML Series Servo Motor

## Features

- Be used to drive the feed shaft of various machine
- Various products(1.0KW ~4.0KW, with brake etc.)
- Equipped with 17-bit incremental/absolute encoder
- Standard configuration is IP65

## Applications

- Machine tools
- Handling machine
- Foodstuff processing machine
- Textile machine

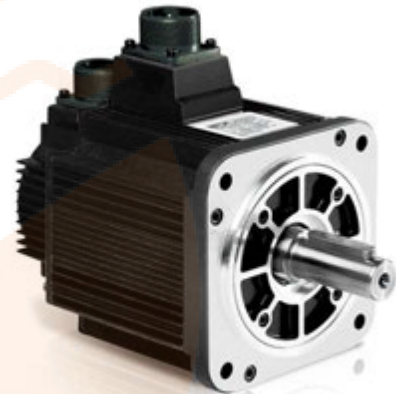

## Model Specification Description

**EML-10      A      D      A      1      1**

EML Model Servo Motor

Rated Power		Power Voltage		Encoder		Design Sequence		Shaft End		Optional Parts	
Sign	Spec.	Sign	Spec.	Sign	Spec.	Sign	Spec.	Sign	Spec.	Sign	Spec.
<b>10</b>	1.0KW	<b>A</b>	200Vac	<b>D</b>	Incremental Encoder: 131072P/R	<b>A</b>	Design Sequence	<b>1</b>	Flat, without keys	<b>1</b>	None
<b>15</b>	1.5KW									<b>2</b>	With Oil Seal
<b>20</b>	2.0KW			<b>S</b>	Absolute Encoder: 131072P/R			<b>2</b>	Flat, with keys, with screw thread	<b>3</b>	With brake (DC24V)
<b>30</b>	3.0KW									<b>4</b>	With oil seal, with brake (DC24V)
<b>40</b>	4.0KW			<b>R</b>	Resolver						

## Rated Value and Specification

ESTUN

Model	Unit	EML-10A	EML-20A	EML-30A	EML-40A
Rated power	Kw	1.0	2.0	3.0	4.0
Rated torque	Nm	9.55	19.1	28.7	38.2
Maximum torque	Nm	28.65	57.3	86.1	114.6
Rated rotation speed	rpm	1000			
Top rotation speed	rpm	1500			
Rated current	A	6	12	18	24
Instantaneous Max. current	A	18	36	54	72
Rotor moment of Inertia (without brake)	E-4Kg.m <sup>2</sup>	18.9952	53.4682	83.9418	114.415
Rotor moment of Inertia (with brake)	E-4Kg.m <sup>2</sup>	19.6064	56.6682	87.1418	117.615
Electric time constant-T <sub>E</sub>	ms	14.09	15.36	18.87	20.2
Mechanical time constant-T <sub>M</sub>	ms	0.96	1.72	1.21	1.09
electromotive force constant-K <sub>E</sub>	V/krpm	122	109	116.6	118
Torque constant-K <sub>T</sub>	Nm/A	1.8725	1.673	1.8709	1.868
Resistance among motor windings	Ω	1.1	0.56	0.3	0.2
inductance among motor windings	mH	15.4~15.5	4.68~8.6	3.05~5.66	2.08~4.04
Insulation level		F			
Insulation impedance		Not less than 50MΩ under normal temperature			
Insulation voltage endurance		AC 1500V, 50Hz,1min			
Running air pressure	kPa	86~106			
Running temperature	℃	-25~+40			
Running humidity		Not more than 90%, under 25℃			
IP level		IP65			

(Note): The values in parentheses are for servo motors with holding brakes.

## Torque-speed feature

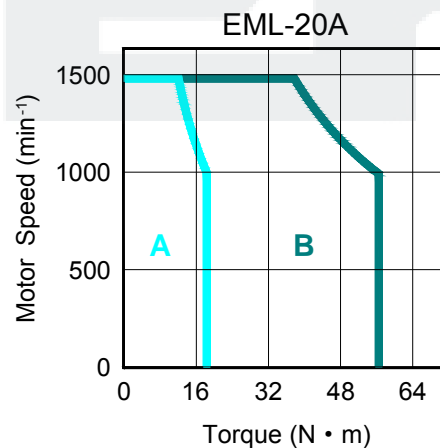
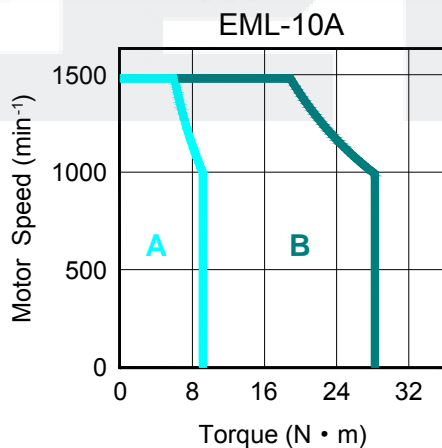

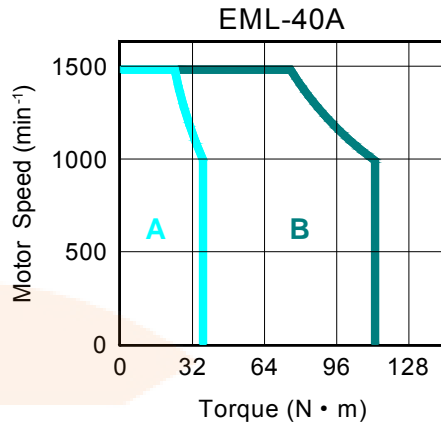
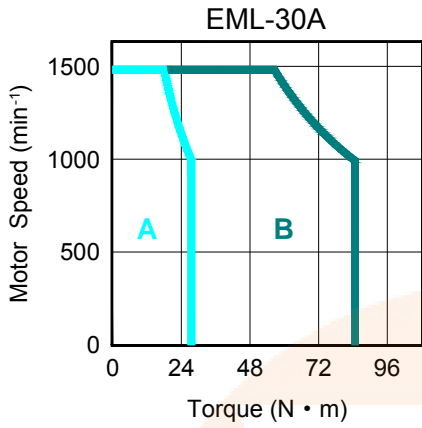

**Dimension**

A: Continuous Working Area B: Repeatable Working Area

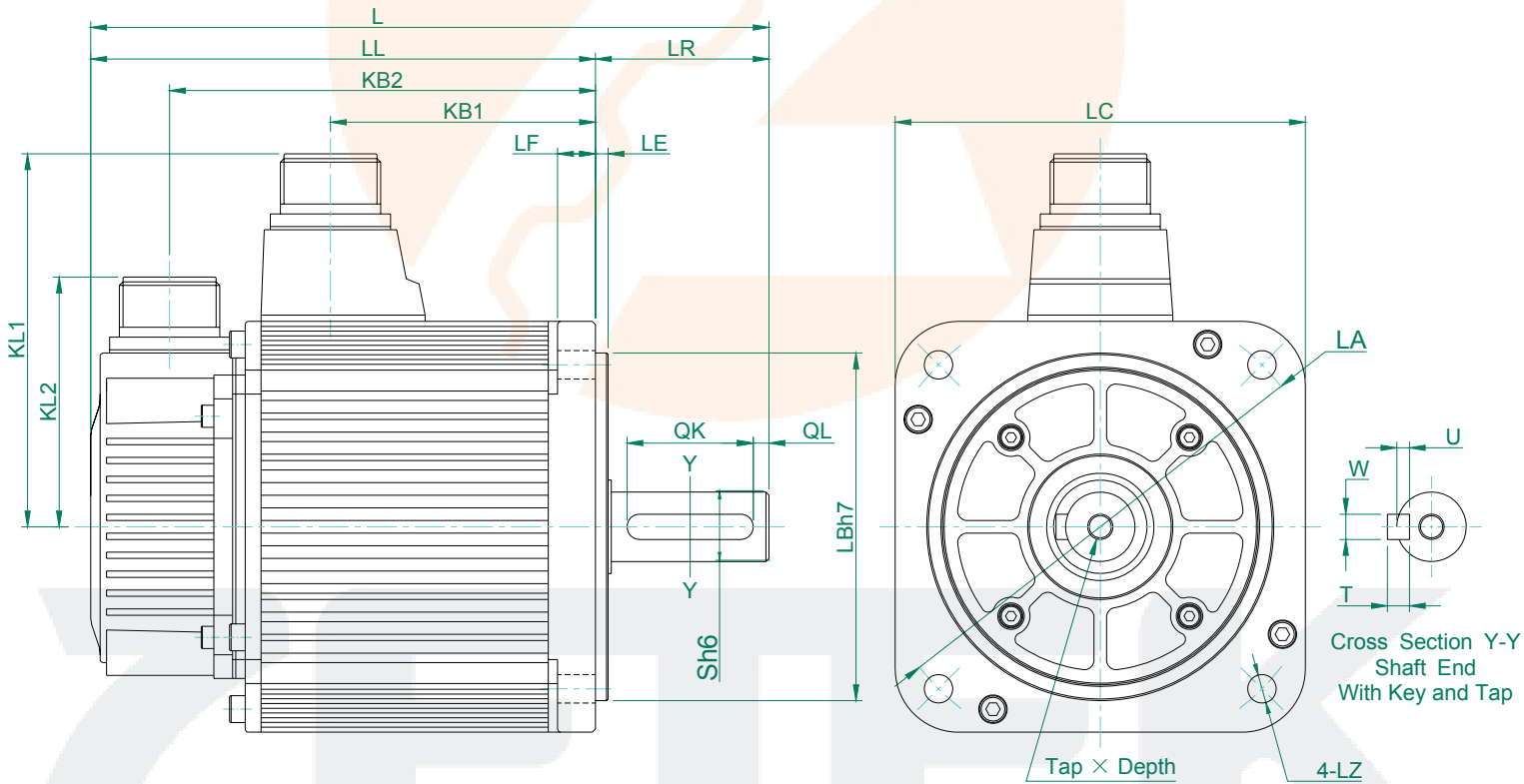

Model EML-	L	LL	KB1	KB2	KL1	KL2	Flange face							S	Tap×De pth	key				
							LR	LE	LF	LC	LA	LB	LZ			QK	QL	W	T	U
10A	265	210	134	185	118	79	55	4	12	130	145	110	9	22	M6x20 L	40	5	8	7	4
20A	332	253	168	228	140	79	79	3.2	18	180	200	114	13.5	35	M8x16 L	55	6	10	8	5
30A	372	293	208	268	140	79	79	3.2	18	180	200	114	13.5	35	M8x16 L	55	6	10	8	5
40A	412	333	248	308	140	79	79	3.2	18	180	200	114	13.5	35	M8x16 L	55	6	10	8	5

# EMB Series Servo Motor

## Features

- Power supply voltage: 400V
- Driving of feed shafts for various machinery
- Various products (7.5KW~15KW, with brake etc.)
- Mounted 17 bits absolute encoder, optional mounted resolver

## Applications

- Machine tools
- Handling machine
- Foodstuff processing machine
- Textile machine



## Model Specification Description

**EMB-1E D S A 1 1**

EML Model Servo Motor

Rated Power		Power Voltage		Encoder		Design Sequence		Shaft End		Optional Parts	
Sign	Spec.	Sign	Spec.	Sign	Spec.	Sign	Spec.	Sign	Spec.	Sign	Spec.
<b>75</b>	7.5KW	<b>D</b>	400Vac	<b>S</b>	Absolute Encoder: 131072P/R	<b>A</b>	Design Sequence	<b>1</b>	Flat, without keys	<b>1</b>	None
<b>1A</b>	11KW							<b>2</b>	Flat, with keys, with screw thread	<b>2</b>	With Oil Seal
<b>1E</b>	15KW			<b>R</b>	Resolver					<b>3</b>	With brake (DC24V)
										<b>4</b>	With oil seal, with brake (DC24V)

## Rated Value and Specification

Model	Unit	EMB-75D	EMB-1AD	EMB-1ED
Rated power	Kw	7.5	11.0	15.0
Rated torque	Nm	47.8	70.0	95.5
Maximum torque	Nm	143.4	190.0	203.0
Rated rotation speed	rpm	1500		
Top rotation speed	rpm	2000		
Rated current	A	18.2	27.7	37.8
Instantaneous Max. current	A	54.6	80.5	76.3
Rotor moment of Inertia (without brake)	E-4Kg.m <sup>2</sup>	186.2	271.6	338.8
Rotor moment of Inertia (with brake)	E-4Kg.m <sup>2</sup>	193.6	278.9	346.1
Electric time constant-T <sub>E</sub>	ms	28.3	43.8	59.4
Mechanical time constant-T <sub>M</sub>	ms	1.3	0.8	0.6
electromotive force constant-K <sub>E</sub>	V/krpm	174.8	168.7	170.4
Torque constant-K <sub>T</sub>	Nm/A	2.7	2.7	2.7
Resistance among motor windings	Ω	0.3	0.1	0.1
inductance among motor windings	mH	4.63/9.07	2.83/5.69	2.37/4.75
Insulation level		F		
Insulation impedance		Not less than 50MΩ under normal temperature		
Insulation voltage endurance		AC1800V, 50Hz, 1min		
Running air pressure	kPa	86~106		
Running temperature	°C	-25~+40		
Running humidity		Not more than 90%, under 25°C		
IP level		IP65		



### Jiangning Development Zone

Jiangning Development Zone is where Estun situates. Fresh air and abundant talent. Here is the base of China High Technology Industry. Giants like Siemens, Motorola are around the corner.

## Torque-speed feature

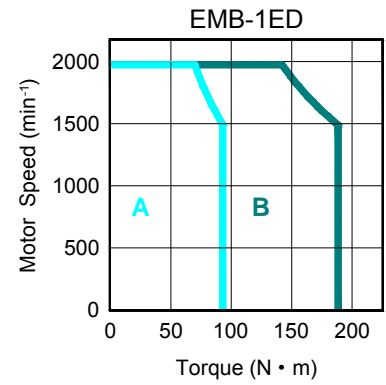
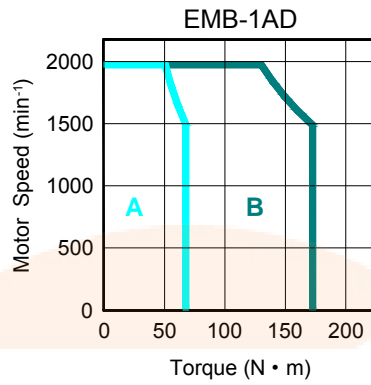
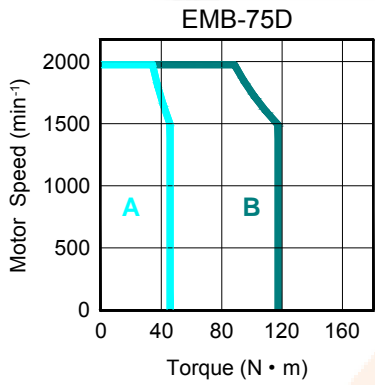

A: Continuous Working Area B: Repeatable Working Area

## Dimension

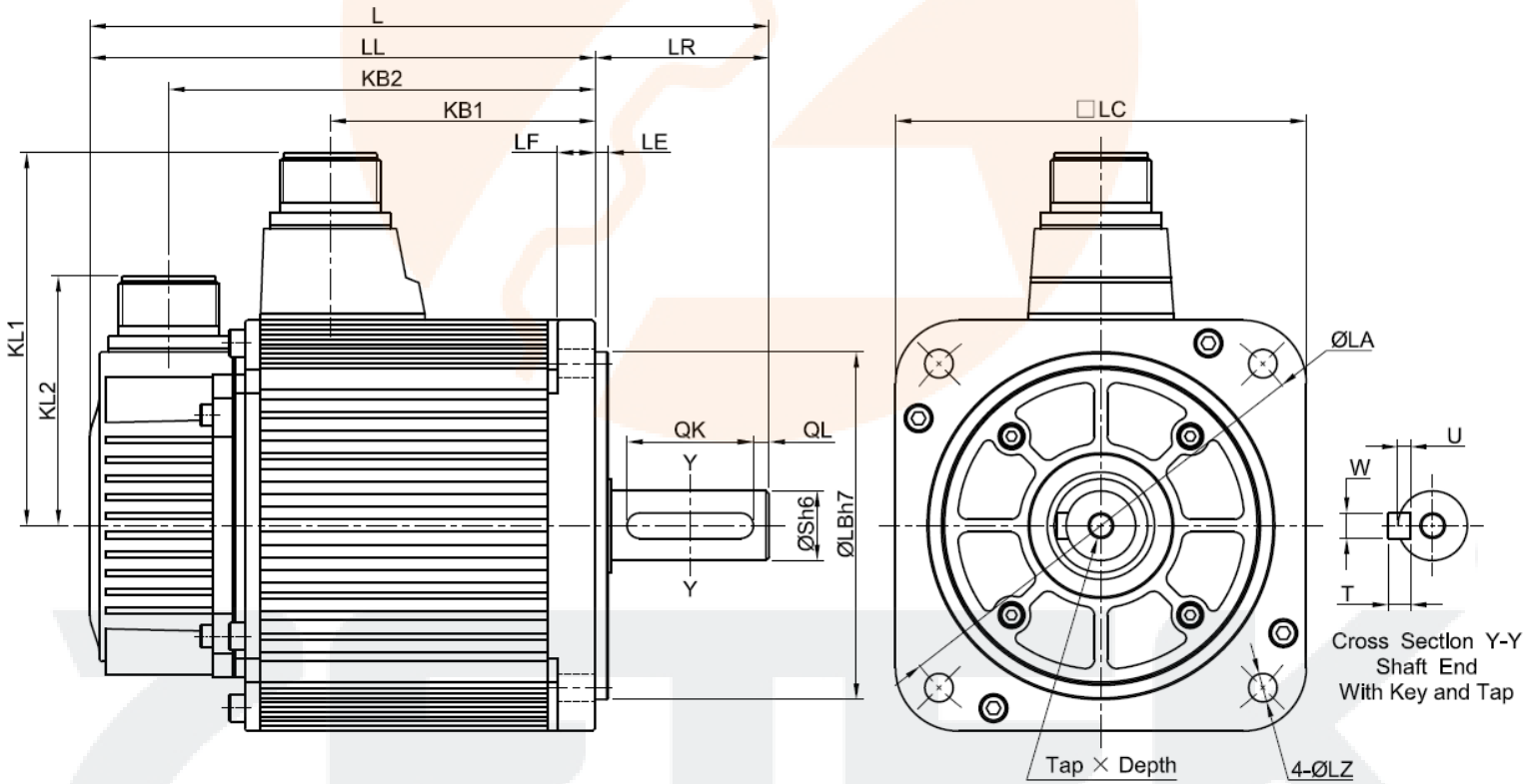

Model EMB-	L	LL	KB1	KB2	KL1	Flange side							S	Tap×Depth	key				
						LR	LE	LF	LC	LA	LB	LZ			QK	QL	W	T	U
75D	530	414	366	302	184	116	4	18	220	235	200	13.5	42	M16×32L	90	6	12	8	5
1AD	580	464	416	352	184	116	4	18	220	235	200	13.5	42	M16×32L	90	6	12	8	5
1ED	615	499	451	387	184	116	4	18	220	235	200	13.5	55	M20×40L	90	6	12	10	6



# Feedback Unit



Motor type	Feedback Unit(Tamagawa)				
	2500P/R incremental Encoder		17-bit Incremental Encoder	17-bit Absolute Encoder	Resolver
	P		D	S	R
	TS5214N369	TS5214N578	TS5668N021	TS5667N420	TS2640N321E64
EMJ-02A	✓				
EMJ-04A	✓		✓	✓	
EMJ-08A		✓	✓	✓	
EMJ-10A		✓	✓	✓	
EMG-10A		✓	✓	✓	✓
EMG-15A		✓	✓	✓	✓
EMG-20A		✓	✓	✓	✓
EML-10A		✓	✓	✓	✓
EMG-30A		✓		✓	✓
EMG-50A		✓		✓	✓
EML-20A		✓		✓	✓
EML-30A		✓		✓	✓
EML-40A		✓		✓	✓
EMB75D				✓	✓
EMB1AD				✓	✓
EMB1ED				✓	✓

Note: 1. Encoder is wire-saving type(8 wires)

2. Power supply is U.V.W. three phase 200Vac for EMJ,EMG &EML series. For EMB series, power supply is 400Vac.

3. Estun Servo motor has four pairs of poles(8 poles) .

4. Estun Servo Motor is supplied with Sine Wave Current and is not Square Wave Current type motor.

5.'✓' represents the feedback unit that a specific motor has.

# Typical applications

## ➤ CNC MACHINE



## ➤ PROCESSING MACHINE



Textile  
Food  
Medical  
Packaging  
Plastics  
Spm  
Printing

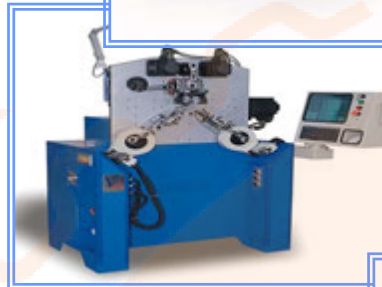

## ➤ OTHERS

Labeling  
Form/Fill/Seal  
Laser cutting/Trimming  
Pharmaceuticals  
Grinding  
Winding  
Robotics  
Drilling  
... and more

