

TNP4

series



Product Segments

• Care Motion

| | |
|---|---------------|
| Maximum available buttons | 15 |
| Color | black or grey |
| Protection class | IP54 or IP66 |
| Option | back cover |
| Control up to 7 channels in connection with TC8 | |
| Mounted into side rail or foot board directly | |
| Can be used as lock-out box | |

Drawing

Standard Dimension

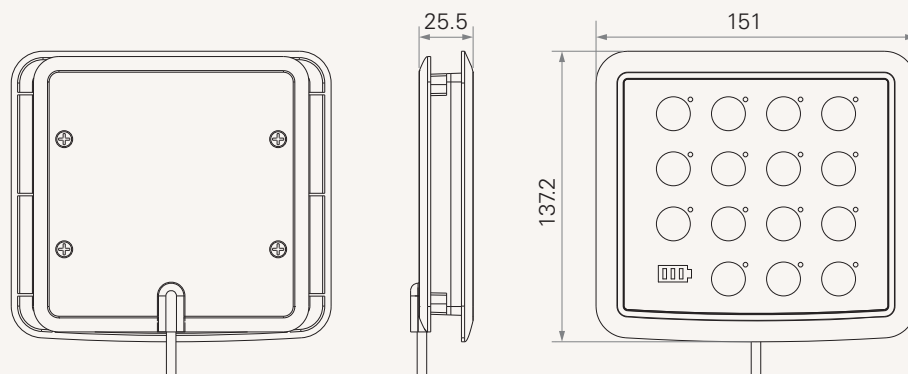

Dimension with Cable length

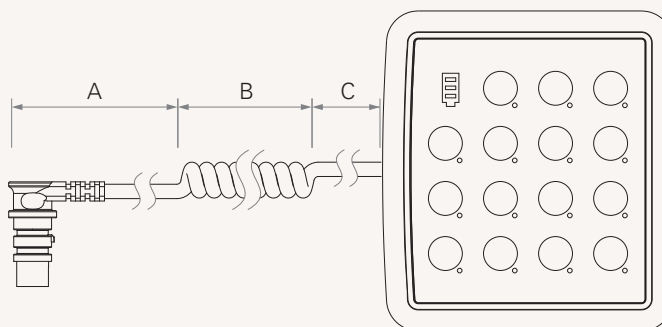

Cable Length (mm)

| CODE | A | B | C |
|------|-------------------|-----|-----|
| 1 | 1000 | 300 | 200 |
| 2 | 1200 | 300 | 300 |
| 3 | 1400 | 300 | 400 |
| 4 | 2400 | 0 | 0 |
| 5 | 0 | 600 | 0 |
| 6 | 1000 | 200 | 200 |
| A | Customized length | | |

Terms of Use

The user is responsible for determining the suitability of TiMOTION products for a specific application.







Due to continuous development in order to improve our products, TiMOTION products are subject to frequent modifications and changes without prior notice.

TiMOTION reserves the right to discontinue the sale of any products displayed on its website or listed in its catalogue or other written materials drawn up by TiMOTION.

TNP4 Ordering Key

TNP4

Version: 20130510-C

| | | | | |
|--|-----------------------|--|---|----------|
|  | Plug | 1 = DIN 8pin, 90°, for TC2/TC3 2 = RJ 10pin, 90°, for TC1/TC8/TC10 4 = DIN 8pin, 180°, for extension cable | 5 = RJ 10pin, 180°, for TC6/TC9/extension cable A = Customized | |
|  | Color | 1 = Black | 2 = Grey (Pantone 428C) | |
|  | IP Protection | 1 = Without | 2= IP54 | 3 = IP66 |
|  | Back Cover | 0 = Without | 1 = With | |
|  | Key Definition | A = Customized | | |
|  | Cable Length | 1~6 = See appendix | A = Customized | |