

# TH1

series



## Product Segments

- **Care Motion**
- **Comfort Motion**

|                           |               |
|---------------------------|---------------|
| Connected actuators       | 1~4           |
| Maximum available buttons | 10            |
| Color                     | black or grey |
| Protection class          | IP54 or IP66  |
| Certificate               | RoHS          |
| Option                    | safety key    |
| LED indication            |               |

## Drawing

Standard Dimension

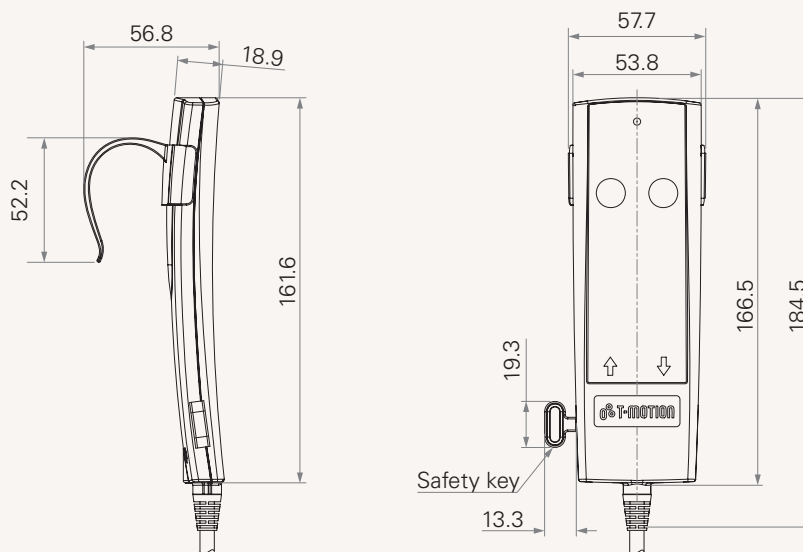

Dimension with Cable Length

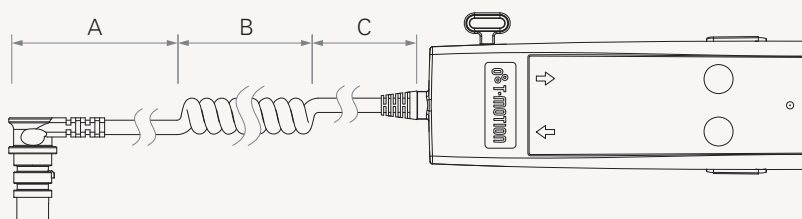

### Cable Length (mm)

| CODE | A                 | B   | C   |
|------|-------------------|-----|-----|
| 1    | 1000              | 300 | 200 |
| 2    | 1200              | 300 | 300 |
| 3    | 1400              | 300 | 400 |
| 4    | 2400              | 0   | 0   |
| 5    | 0                 | 600 | 0   |
| 6    | 1000              | 200 | 200 |
| A    | Customized length |     |     |

### Terms of Use

The user is responsible for determining the suitability of TiMOTION products for a specific application.







Due to continuous development in order to improve our products, TiMOTION products are subject to frequent modifications and changes without prior notice.

TiMOTION reserves the right to discontinue the sale of any products displayed on its website or listed in its catalogue or other written materials drawn up by TiMOTION.

# TH1 Ordering Key

TH1

Version: 20131122-G

|  |                            |   |              |   |       |
|--|----------------------------|---|--------------|---|-------|
|  | <b>Number of Actuators</b> | 1 = 1   | 2 = 2        | 3 = 3   | 4 = 4 |
|  | <b>Plug</b>                | 1 = DIN 8pin, for TC2/TC3/TC7<br>2 = RJ 10pin, 90°, for TC1/TC8/TC10<br>4 = DIN 8pin, 180°, for extension cable |              | 5 = RJ 10pin, 180°, for TC6/TC9/extension cable<br>A = Customized |       |
|  | <b>Color</b>               | 1 = Black   |              | 2 = Grey (Pantone 428C)   |       |
|  | <b>IP Protection</b>       | 1 = Without   | 2 = IP54     | 3 = IP66  |       |
|  | <b>Safety Key</b>          | 0 = Without   |              | 1 = With  |       |
|  | <b>Hook Type</b>           | 0 = None  | 1 = Standard | 2 = Magnetic  |       |
|  | <b>Key Definition</b>      | A-b = See appendix*<br>Note : please contact TiMOTION before making an order                                    |              | 1 = Customized  |       |
|  | <b>Cable Length</b>        | 1~6 = See appendix  |              | A = Customized  |       |